

Name	Anbauschuppen A 160x280_28		
Profil	2.8x11.4	Zeichnung	3D
			Datum 21.12.2021

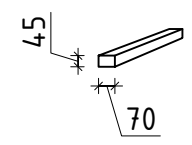
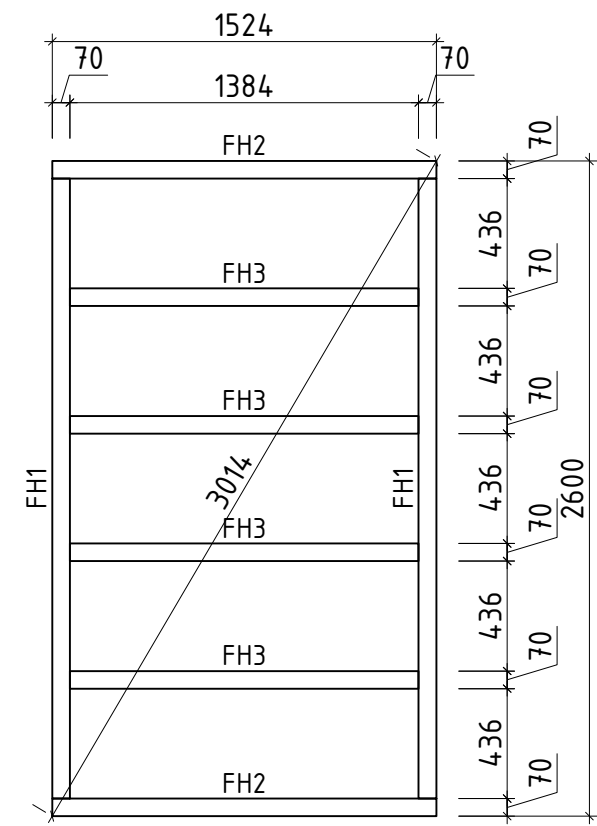
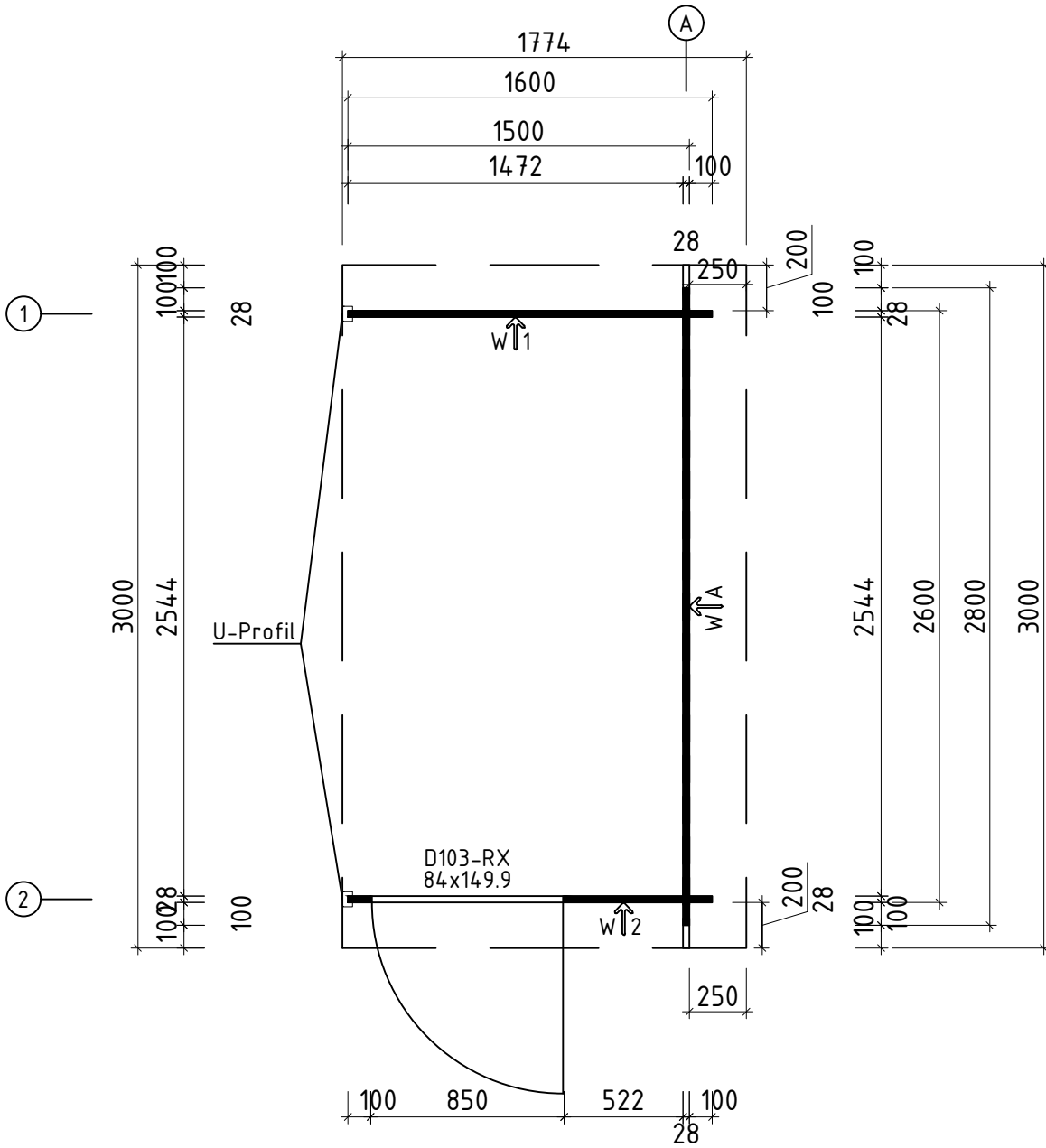

Q2 – Qualitätsklasse für Fenster und Türen

Name	Anbauschruppen A 160x280_28		
Profil	2.8x11.4	Zeichnung	Grundplan, Lagerholzplan
		Datum	21.12.2021

Pos	Teileliste Anbauschuppen A 160x280_28	Stck.	Profil (mm)	Länge (mm)	
	Achtung! Die Giebelbohlen können teilweise schon vormontiert sein! Bitte beachten - diese erscheinen nicht ganz so wie in der Teileliste beschrieben.				
001		1	28x114	3000	
002		12	28x114	2800	
004		1	28x57	1600	
005		12	28x114	1600	
009		12	28x114	650	
010		1	28x57	650	
012		12	28x114	100	
013		1	28x57	100	
W1-1		1			
W2-1		1			
FH1	FUNDAMENTHÖLZER (imprägniert) 	2	70x45	2460	
FH2	FUNDAMENTHÖLZER (imprägniert) 	2	70x45	1524	
FH3	FUNDAMENTHÖLZER (imprägniert) 	4	70x45	1384	
PF1	PFETTEN 	1	44x145	3000	
	DACHBRETTER		27+1	113x18	1840
	FUSSBODENBRETTER		14+1	113x18	2540
	FUSSBODENLEISTEN			18x40	9.0lfm
G02-1	GIEBELBRETTER 18x120		2	18x120	1860
G05-1	GIEBELDECKLEISTEN 18x40		2	18x40	1840
T01-1	TRAUFBRETTER 18x95		1	18x95	3000
T04-1	TRAUFENDECKLEISTEN 18x40		1	18x40	3036
T06-1	TRAUFENLEISTEN 18x40		2	18x40	3000
UP1-1	U-PROFIL 28		2	44x65	1876

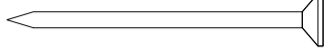
Pos	Teilleiste Anbauschuppen A 160x280_28	Stck.	Profil (mm)	Länge (mm)
SM-1	Sturmleisten 	2	18x40	1370
SH	Schlaghölzer 	3		
NG2 550	NÄGEL 2.5x50 Dachbretter 	108		
NG2 550	NÄGEL 2.5x50 Fussbodenbretter 	168		
SR3 030	SCHRAUBEN 3.0x30 Fussbodenleisten 	18		
SR3 030	SCHRAUBEN 3.0x30 Giebeldeckleisten 	8		
SR3 030	SCHRAUBEN 3.0x30 Traufendeckleisten 	6		
SR3 030	SCHRAUBEN 3.0x30 Traufenleisten 	12		
SR3 545	SCHRAUBEN 3.5x45 Giebelbretter 	8		
SR3 545	SCHRAUBEN 3.5x45 Traufenbretter 	6		
SR5 0100	SCHRAUBEN 5.0x100 Fundamenthölzer 	32		
SS013	Schloßschrauben M8x60 Mutter M8 U-Scheibe Ø25 - Befestigung für Sturmleisten 	6		
	✓- bitte selber anpassen (falls nötig)!			
Kood	Anbauschuppen A 160x280_Material	File	Anbauschuppen A 160x280_28.dwg	2/3

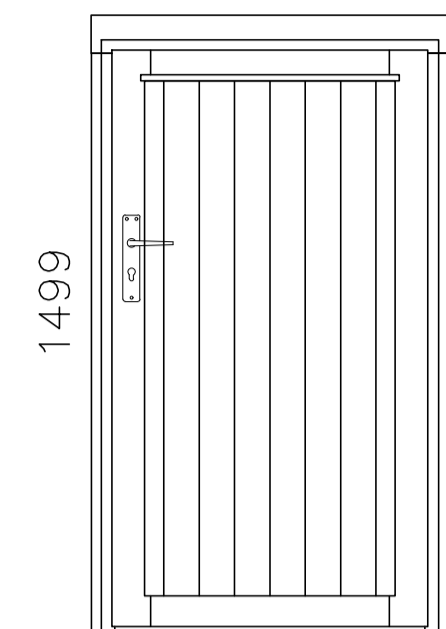
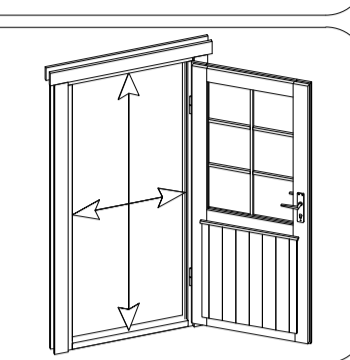
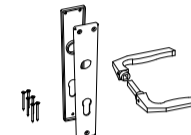
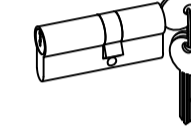
Pos	Teieliste Anbauschuppen A 160x280_28	Stck.	Profil (mm)	Länge (mm)
	<p>TÜR 840x1499 D2-S28R-XXX-08401499</p> <p>Q2 D103-RX 840</p>  <p>1499</p> <p>Right handed / DIN rechts / paremakäeline</p> <p>Clear opening/ durchgangsmaß/ ava suurus 752x1411mm</p> 	1		
UL-Q 2-Q3	Q2-Q3 Door handle - Türgriff - Ukselink		1	
LS-Q4	Q4 Cylinder lock - Zylinderschloss - Lukusüdamik		1	

Uks	Q2-Q3	-	koostamisjuhhis
Door	Q2-Q3	-	assembly instructions
Tür	Q2-Q3	-	Montageanleitung

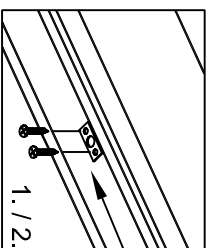
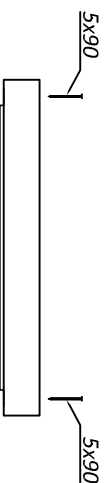

Ø8-10

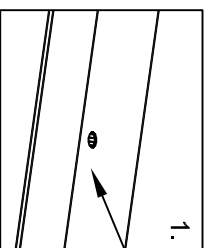
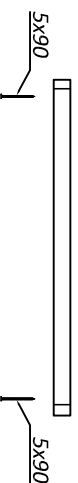
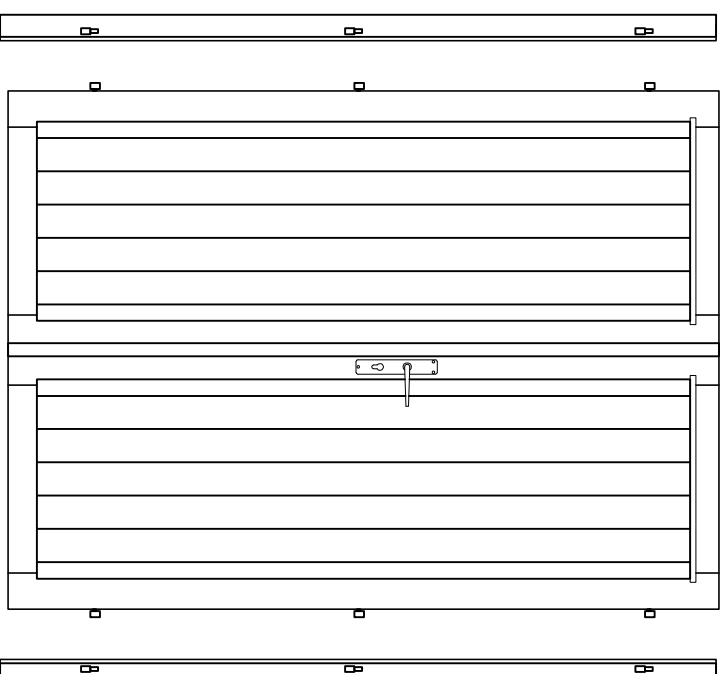
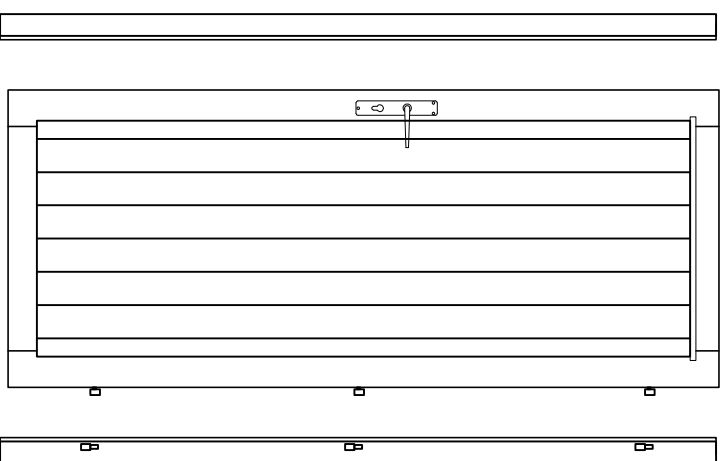
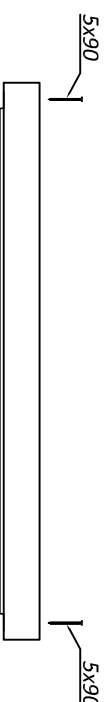

Ø8-10

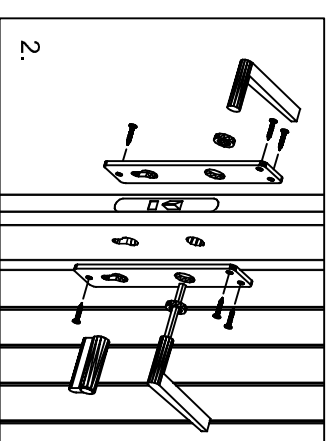
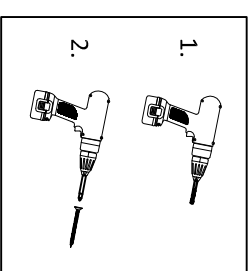

*Kui hinged ei ole paigaldatud!
 *When hinges are not attached!
 *Wenn Scharniere sind nicht angebracht!

*Kui ühepoolne uks ei ole kokku pandud!
 *When single door is not assembled!
 *Wenn Einzeltür ist nicht zusammengebaut!

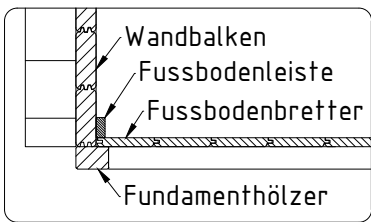
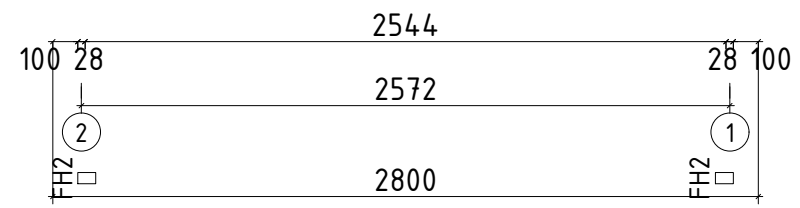
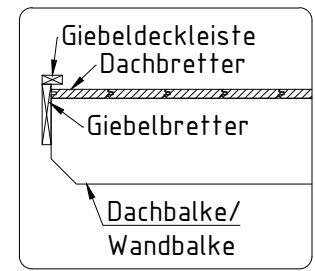
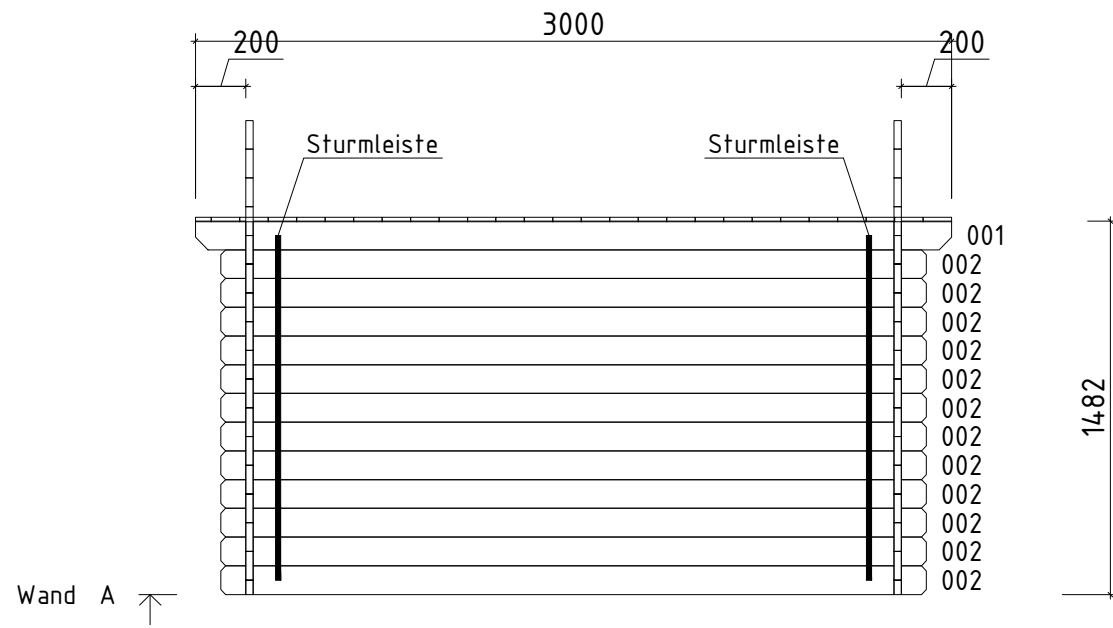

Name		Anbauschuppen A 160x280_28	
Profil	2.8x11.4	Zeichnung	WAND A
		Datum	21.12.2021

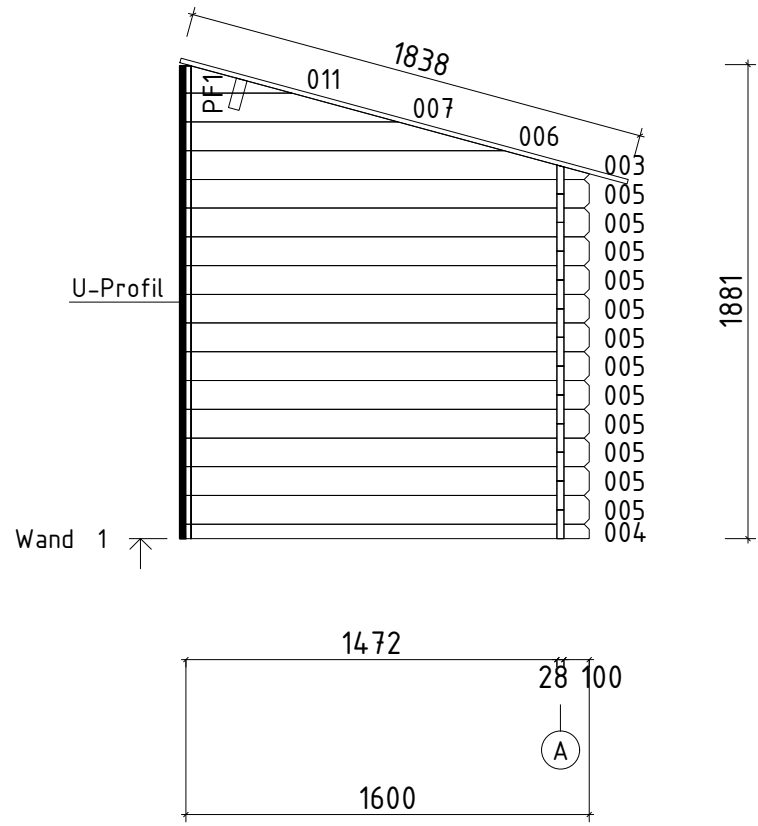

Name		Anbauschuppen A 160x280_28	
Profil	2.8x11.4	Zeichnung	WAND 1
		Datum	21.12.2021

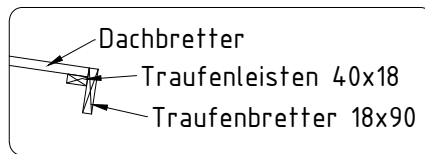
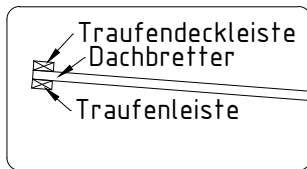
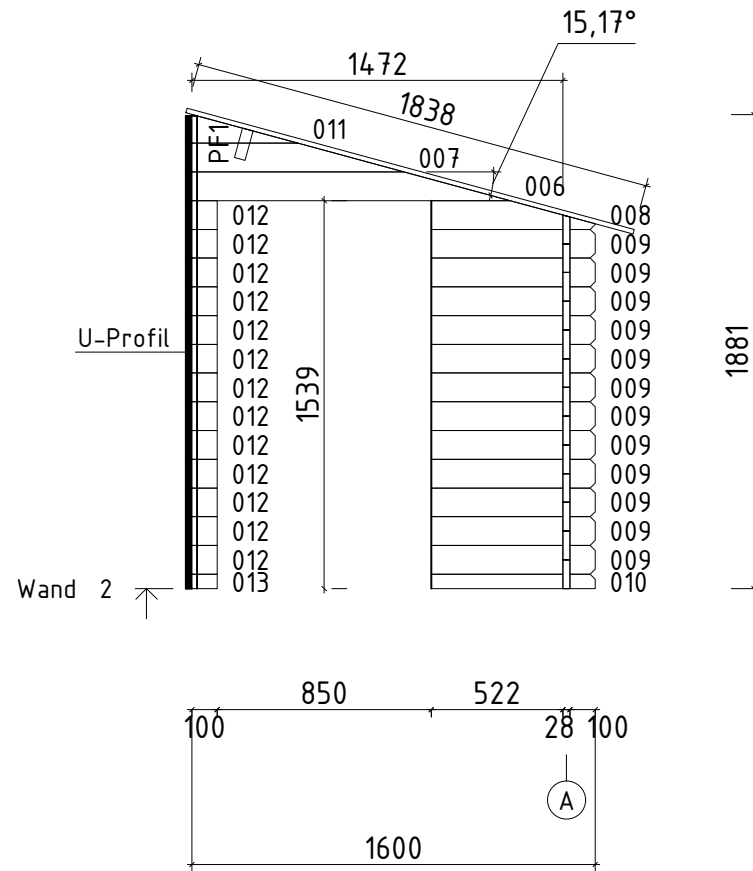

Name	Anbauschruppen A 160x280_28		
Profil	2.8x11.4	Zeichnung	WAND 2
		Datum	21.12.2021